

Regulations and Requirements for import and export of Food In ASEAN

Panadda Silva

**Deputy Director, NIMT and Co-Chair of
ASEAN Testing Laboratory Committee**

18 January 2016



National Institute of Metrology (Thailand)

Food safety and trading in ASEAN

1. Stakeholders

1. Standard bodies (standards)
2. Accreditation bodies (Quality system and competency)
3. Testing laboratories
4. Metrology(traceability chain)
5. Exporters, Importers
6. Regulators
7. Regional and International Harmonization Bodies
 - Global: Codex, ISO etc.
 - ASEAN: PFPWG, AFTLC, FSWG etc.



National Institute of Metrology (Thailand)

2

Thailand: Kitchen of the World

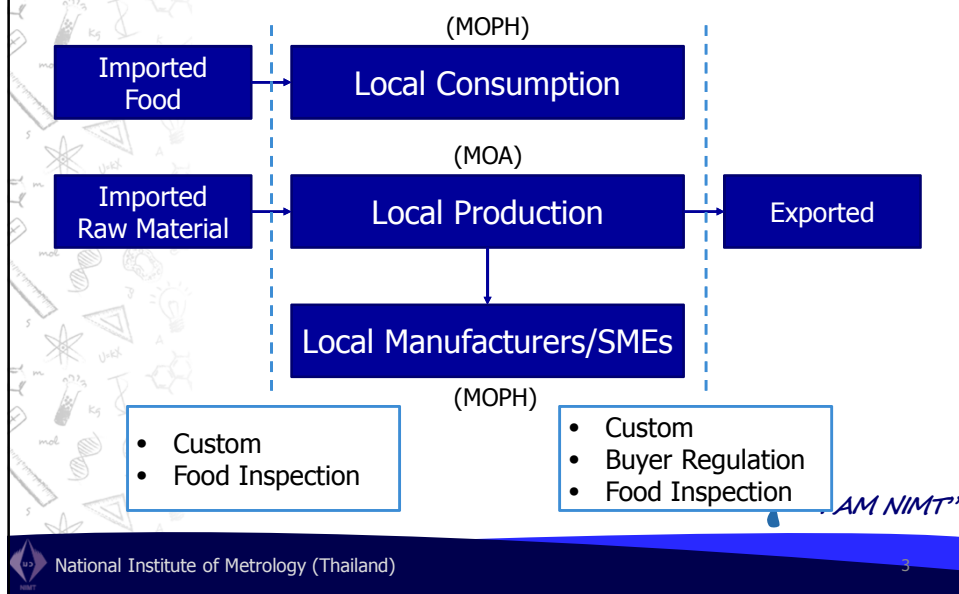

Accepting for import and export procedures

- **Need testing certificates**
- **Accredited laboratory**
- **MRA member of Accreditation Bodies**
- **Method used**
- **etc.**



ASEAN Countries



Three Main Pillars of ASEAN Community

- **ASEAN Economic Community: AEC**
- **Socio-Cultural Pillar**
- **Political and Security Pillar**



ASEAN Economic Community (AEC)

- 2020 → 2015
- Follows EU concept



Year 2015

- Free trade
- Present situation
- Existing committees ACCSQ - (11 WGs)
(ASEAN Consultative Committee for Standard and Quality)
- Ministry of Industrial as a main stakeholder
(Incorporate with MOA and MOPH)



Working Groups under ACCSQ

- (1) Working Group on Mutual Recognition Arrangements (WG 1)
- (2) Working Group on Accreditation and Conformity Assessment (WG 2)
- (3) Working Group on Legal Metrology (WG 3)
- (4) ASEAN Cosmetics Committee (ACC)
- (5) Automotive Product Working Group (APWG)
- (6) Joint Sectoral Committee for Electrical and Electronic Equipment (JSC EEE)
- (7) Medical Device Product Working Group (MDPWG) / ASEAN Medical Device Committee (AMDC)
- (8) Pharmaceutical Product Working Group (PPWG)
- (9) Prepared Foodstuff Product Working Group (PFPWG)
- (10) Rubber Based Product Working Group (RBPWG)
- (11) Traditional Medicines and Health Supplement Product Working Group (TMHS PWG)



AEC

Starting Date

31 December 2015



ASEAN Mechanism



ASEAN Standards & Conformance Framework



- 1. Ensure Quality, Safety, Health and Environment
- 2. Facilitate Trade and Market Access

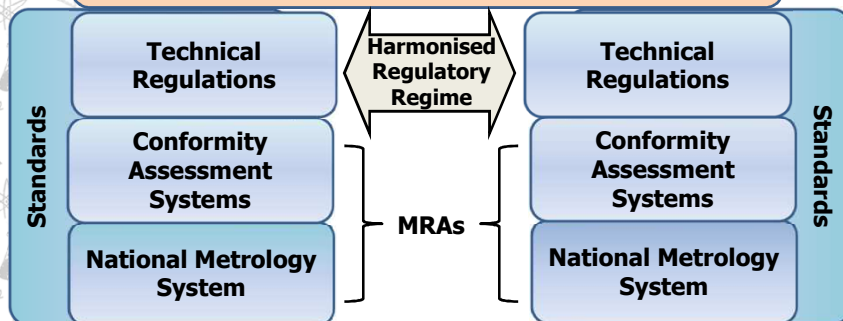

Recognition amongst ASEAN Member States

ACCSQ – PFPWG (Established in 2003)

Scope of Activities:

- Exchange of information on standards, regulations, procedures and mandatory requirements in Member Countries related to prepared foodstuff;
- Review and analyze the comparative study of regulatory regimes among Member Countries
- Identify areas for possible harmonization and MRAs;
- Develop, implement and monitor the sectoral MRAs
- Identify the technical infrastructure needs and build-up mutual confidence in testing and conformity assessment



ACCSQ – PFPWG (Established in 2003)

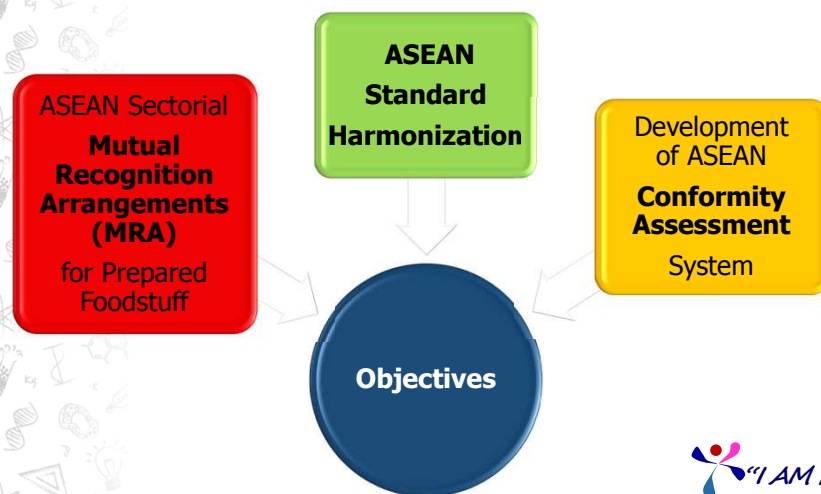

ASEAN Conformity Assessment Technical Infrastructure

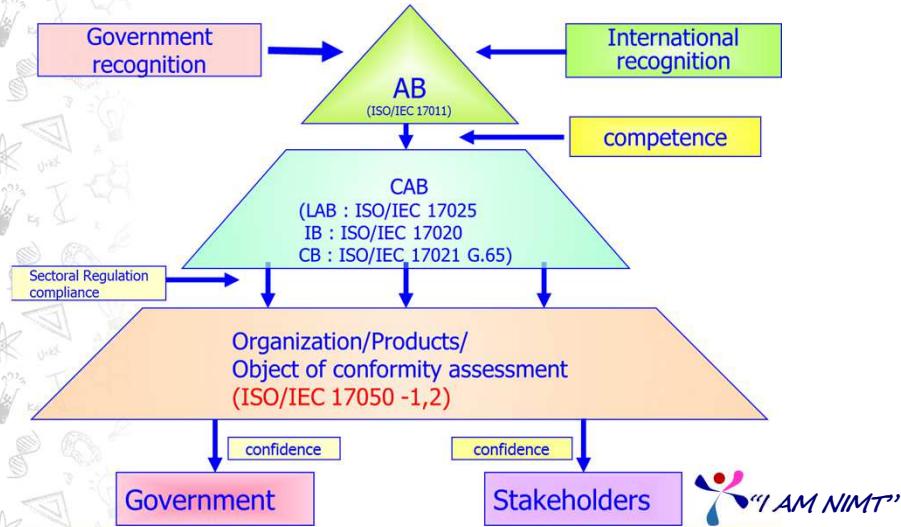

Objective

To strengthen the ASEAN food manufacturing and trading as well as food safety.



Establishment of AFTLC

- In 2010, the tentative ASEAN Food Testing Laboratory Experts (AFTLEs) were formed by ACCSQ PFPWG. Accordingly, the 1st - 3rd AFTLE meetings were held by the Expert group.
- In 2012, ACCSQ PFPWG agreed to establish the ASEAN Food Testing Laboratory Committee (AFTLC).
 - comprised of members directly involved in laboratories.
 - chaired by Thailand, co-chaired by Singapore.

Meeting	Year	Venue
1	Jun 2012	Thailand
2	Dec 2012	Malaysia
3	Jun 2013	Vietnam
4	Feb 2014	(Brunei Darussalam)

Cascading Concept

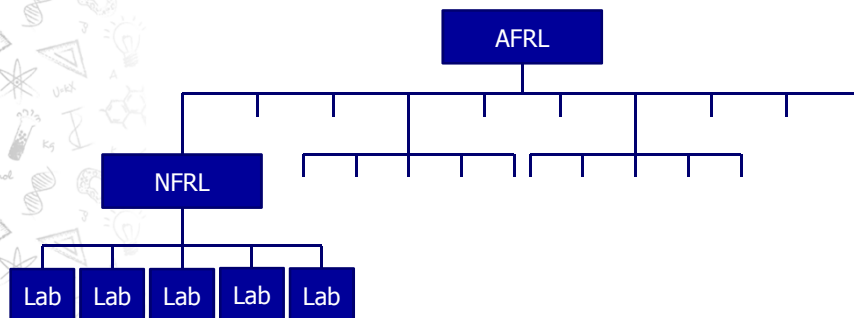

How to Establish AFRL?

1. In which area?
2. Process?



Area Prioritized

1. Food safety
2. Trade



AFRL Requirements



General Requirements

- 1. Government labs**
- 2. Supportive policy from management**
- 3. ISO/IEC 17025 accredited and international recognition**
- 4. Participate in PT (Internationally competence)**
- 5. Provide/coordinate PT (international standard)**
- 6. Information source for CRMs**



Present Situation



Present AFRLs in 9 Areas since 2004

- **9 AFRLs have been agreed:**
 - **Vet drug residues : Thailand**
 - **Heavy metals and trace elements : Thailand**
 - **Pesticide residues : Singapore**
 - **Mycotoxin : Singapore**
 - **Food microbiology : Vietnam**
 - **GMO : Malaysia**
 - **Food additive : Indonesia**
 - **Food packaging and contact material : Thailand**
 - **Environmental contaminants : Singapore**



Benefit of AFRL

1. Food safety for all
2. Facilitate trade
3. Technical competency of the region to the global
4. Enhance food control system
5. Provide acceptance among ASEAN members and international stakeholders



ASEAN as one!



NIMT



Important Factors

- **Testing Laboratories (methods)**
- **Accreditation Bodies (criteria)**
- **Proficiency testing (traceability)**
- **Reference material (traceability)**
- **State of Development of each Member State**



Methods (including Traceability)

- **ISO**
- **Codex**
- **EU**
- **Japanese**

etc.

Comparable and acceptable



Accreditation Bodies

- **MRA – ILAC, APLAC**
- **MS – not MRA members**
- **WG2**



Traceability

- **Equipment**
- **RM**
- **PT** **using true value**
NOT consensus value



State of Development of each Member State

ASEAN as one!









Stand on our own legs!



When wind blows ...

Some build walls.

Some build windmills.



National Institute of Metrology (Thailand) 33

Thank you!



National Institute of Metrology (Thailand) 34